

perilla
senin için



perilla.com.tr

**Ürün
Katalođu**
Product
Catalogue



Senin için üretiyoruz
Senin için tasarlıyoruz
Senin için hayatı kolaylaştırıyoruz

Senin için kaliteden ödün vermiyoruz

We manufacture for you
We design for you
We make life easier for you

We dont give any tolerance from quality for you



Intertek

Teknik ve Sosyal Denetimler



DIN EN ISO 9001:2015



Trade with purpose



Certificate No
URS-T-10-2892



Empowering responsible
leadership

Hakkımızda / about us

Doğrular Ev Ürünleri 1979 yılında Ev gereçleri üretimi, pazarlaması ve satışını yapmak üzere kurulmuştur. Üretim faaliyetlerini Konya'da 132.000 m², Rusya / Tula'da 41.000 m² alan üzerine kurulu modern üretim tesislerinde, 650 kişilik profesyonel ekibiyle yapmaktadır. Satış ve dağıtımını ise İstanbul'da 5300 m² lik lojistik merkezinde, Rusya / Moskova şubeleri ile Konya merkezde yürütmektedir.

Kalıcı bir dünya firması olmak isteyen DOĞRULAR, en önemli rekabet gücünün inovasyon, kalite ve müşteri memnuniyetinin olduğu bilinciyle hareket eder. DOĞRULAR' da ürünlerin tasarımından, nihai tüketicinin kullanımına kadar geçen tüm süreçler, müşteri memnuniyeti ve kalite odaklıdır.

Ulusal ölçekte Türkiye'deki başarısını, dünya pazarlarına "PERİLLA" markasıyla taşımayı hedeflemektedir. Bu süreçte, firmanın iştiraklerinden biri olan DOĞRU METAL EV GEREÇLERİ A.Ş.'nin pazar arabası ürünlerini de "PERİLLA" markasıyla sunmaktadır. Doğrular, 45 yılı aşkın sanai ve ticari yolculuğunda değişimin hep bir adım önünde gitmeyi benimsemiş örnek bir şirket olmuştur.

En önemli misyonu ve sloganı "senin için" olmuştur. DOĞRULAR, Ütü masası, merdiven, çamaşır kurutma askısı, pazar arabası ve kamp ürünleri başta olmak üzere tüm ürünlerinde son kullanıcıların yaşamlarına kolaylık sağlamaktadır.

Önümüzdeki 10 yılda ki hedefi, İstanbul Sanayi Odası'na her yıl yayınlanan "Türkiye'nin 500 Büyük Sanayi Kuruluşu" listesinde yer almak, üretimdeki mevcut ihracat payını %80 'lere çıkarabilmek ve bu hedef doğrultusunda, kararlılıkla faaliyet göstermektir. Bu hedefler doğrultusunda en büyük destekçimiz ise yıllardır hiç eksilmeyen "önce doğruluk" ilkesiyle beraber müşteri odaklı ticaret, sürekli iyileştirme çalışmaları ve kurumsal yönetim anlayışıdır.

Sağlık, güvenlik ve çevre yönetimini, faaliyetlerinin ayrılmaz bir parçası olarak kabul eder. Çevreye, dolayısıyla insanlığa faydalı tüm projeleri destekleyerek hayata geçirir. Kurumsal dünya misyonunun çevreci anlayışına katkı sunmak amacıyla Tüm Fabrika alanında güneş enerji santralleri kurulmuştur. Dünya ekosistemine diğer katkılarında birisi de yağmur suyu toplama projesinin hayata geçmesidir.

Doğrular Ev Ürünleri was established in 1979 to manufacture, to market and to sell household appliances. It carries out its manufacturing activities with a professional team of 650 people in its modern production facilities established on an area of 132.000 m² in Konya and 41.000 m² in Russia/ Tula. It carries out its sales and distribution in Istanbul logistics center (5300 m²), in the main factory Konya with and Russia / Moscow branch.

DOĞRULAR, which wants to be a permanent world company, acts with the awareness that the most important competitive power is innovation, quality and customer satisfaction. At DOĞRULAR, all processes from the design of the products to the use of the final consumer are focused on customer satisfaction and quality.

It aims to carry its success in Turkey on a national scale to the world markets with the brand "PERİLLA". In this process, it offers the shopping trolleys of DOĞRU METAL EV GEREÇLERİ A.Ş., one of the subsidiaries of the company, under the brand "PERİLLA". In its industrial and commercial journey of more than 45 years, Doğrular has always been an exemplary company that has adopted to stay one step ahead of change.

Its most important mission and slogan has been "live in comfort". DOĞRULAR provides convenience to the lives of end users with all of its products, especially ironing board, ladder, laundry dryers, shopping trolleys and camping products.

Its goal for the next 10 years is to be on the list of "Turkey's Top 500 Industrial Enterprises" published every year by the Istanbul Chamber of Industry, to increase its current export share in production to 80%, and to operate with determination in line with this target. In line with these goals, our biggest supporter is customer-oriented trade, continuous improvement studies and manner of corporate governance, along with the principle of "faithfulness first", which has never diminished for years.

It accepts health, safety and environmental management as an integral part of its activities. It supports and implements all projects that are beneficial to the environment and therefore to humanity. In order to contribute to the manner of environmentalist of the corporate world mission, solar power plants were established in the whole factory area. One of its other contributions to the world ecosystem is the realization of the rainwater harvesting project.





KONYA / TURKEY - ÜRETİM KAMPÜSÜ / PRODUCTION CAMPUS



Feel

**the
comfort**

Product Name

Diva

Teknik Özellikler

Technical Specifications

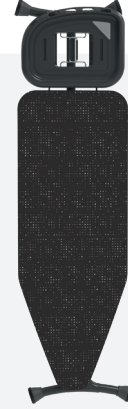

KOD
Code
14011

RENK
Color

44x125

perfore/mesh

0,078 m² / pcs
40HC 892



Ø38

1 Pcs

51 Pcs

56 - 90 cm

Box Barcode



Product Name

Premium

Teknik Özellikler

Technical Specifications



KOD
Code
14013-1

RENK
Color

44x152

monoblock

0,072 m² / pcs
40HC 970



Ø25 - Ø51

2 Pcs

72 Pcs

80 - 94 cm

Box Barcode
18691913004507



Product Name

Valeria

Teknik Özellikler

Technical Specifications

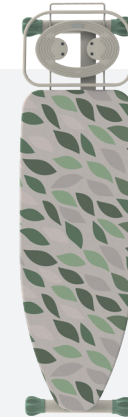

KOD
Code
14004

RENK
Color

43x124

monoblock

0,065 m² / pcs
40HC 1078



20x60 - Ø51

2 Pcs

72 Pcs

60 - 90 cm

Box Barcode
18691913004644



Product Name

Liana

Teknik Özellikler

Technical Specifications



KOD
Code
15014

RENK
Color

44x120

monoblock

0,063 m² /pcs
40HC 1116



Ø25 - Ø51

2 Pcs

80 Pcs

76 - 100 cm

Box Barcode
18691913011734



Product Name

Nano

Teknik Özellikler

Technical Specifications

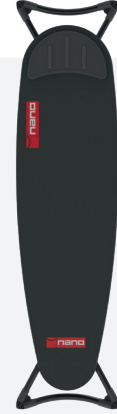

KOD
Code
15028

RENK
Color

38x140

monoblock

0,044 m² /pcs
40HC 1600



Ø25

4 Pcs

96 Pcs

78 - 98 cm

Box Barcode
18691913011802



Product Name

Tidy

Teknik Özellikler

Technical Specifications

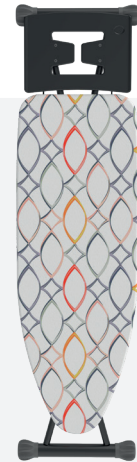

KOD
Code
15025

RENK
Color

43x124

monoblock

0,063 m² /pcs
40HC 1116

Ø25 - Ø51

2 Pcs

72 Pcs

74 x 98 cm

Box Barcode
18691913011789



Product Name
Alece

Teknik Özellikler
Technical Specifications



KOD
Code
15017

RENK
Color
Green

38x130

monoblock

0,039 m² / pcs
40HC 1880

Ø25 - Ø38

4 Pcs

96 Pcs

70 - 90 cm

Box Barcode
18691913003531

8 691913 121313

Product Name
Rachel

Teknik Özellikler
Technical Specifications



Boru Kapama
Plastik'i



KOD
Code
15023

RENK
Color
Black

45x125

monoblock

0,039 m² / pcs
40HC 1784

Ø25

4 Pcs

112 Pcs

78 - 98 cm

Box Barcode
08691913150207

8 691913 150238

Product Name
Tomris

Teknik Özellikler
Technical Specifications



KOD
Code
15018

RENK
Color
Green

40x120

monoblock

0,042 m² / pcs
40HC 1756

Ø21 - Ø38

4 Pcs

96 Pcs

72 - 94 cm

Box Barcode
18691913011765

8 691913 1201138

Product Name
Silvia

Teknik Özellikler
Technical Specifications



KOD Code
15030

RENK Color
Green

36x112

monoblock

0,035 m² /pcs
40HC 2016

Ø21 - Ø38

4 Pcs

96 Pcs

70 - 90 cm

Box Barcode
08691913150351

8 691913 150306



Product Name
Present

Teknik Özellikler
Technical Specifications

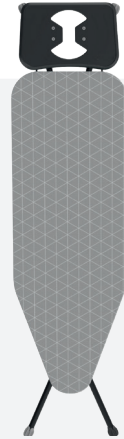

KOD Code
15002

RENK Color
Black

38x110

perfore/mesh

0,033 m² /pcs
40HC 2092

Ø21

4 Pcs

112 Pcs

67 - 89 cm

Box Barcode
18691913011697

8 691913 500084



Product Name
Eko Class

Teknik Özellikler
Technical Specifications

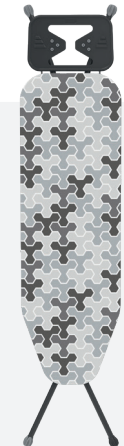

KOD Code
15001

RENK Color
Black

33x105

perfore/mesh

0,024 m² /pcs
40HC 2976

Ø19

4 Pcs

180 Pcs

67 - 89 cm

Box Barcode
18691913011680

8 691913 000021



Product Name
Lamess

Teknik Özellikler
Technical Specifications



KOD
Code
15015

RENK
Color

33x110

monoblock

0,013 m² / pcs
40HC 3032

Ø19



4 Pcs

180 Pcs

67 - 89 cm

Box Barcode
18691913000288

8 691913 121801

Product Name
İnci

Teknik Özellikler
Technical Specifications



KOD
Code
15010

RENK
Color

33x110

perfore/mesh

0,026 m² / pcs
40HC 2664

Ø21



4 Pcs

160 Pcs

65 - 89 cm

Box Barcode
18691913011727

8 691913 500125

Product Name
Gigi

Teknik Özellikler
Technical Specifications

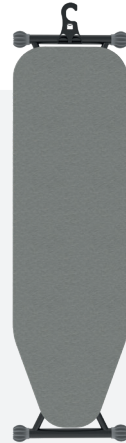

KOD
Code
15024

RENK
Color

33x110

perfore/mesh

0,023 m² / pcs
40HC 3552

Ø19 - Ø28

4 Pcs

180 Pcs

66 - 83 cm

Box Barcode
08691913150320

8 691913 150269

Yeni

Product Name
Flip Mini

Teknik Özellikler
Technical Specifications



KOD
Code
15123

RENK
Color
36x86



Plastik/Plastic

0,0211 m² /pcs
40HC 3306

6 Pcs

192 Pcs

14 cm

Box Barcode
18691913011307



Product Name
Mini

Teknik Özellikler
Technical Specifications

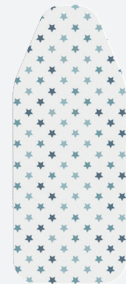
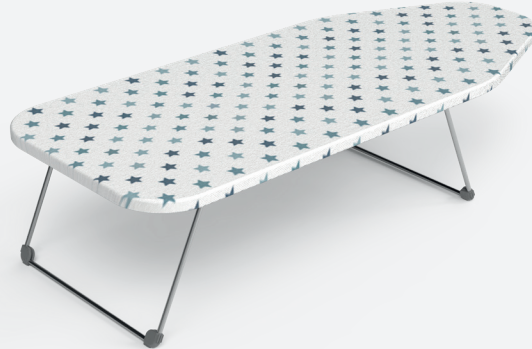

KOD
Code
15120

RENK
Color
30x74



perfore/mesh

0,005 m² /pcs
40HC 12770

4 Pcs

700 Pcs

15 cm

Box Barcode
08691913403228



Product Name

Alsu

Teknik Özellikler

Technical Specifications



KOD
Code
15016

RENK
Color

30x97

perfore/mesh

0,020 m² / pcs
40HC 3672

Ø19



6 Pcs

180 Pcs

70 - 90 cm

Box Barcode
18691913011758



Product Name

IB-1005

Teknik Özellikler

Technical Specifications



KOD
Code
15022

RENK
Color

36x112

monoblock

0,035 m² / pcs
40HC 2016

Ø25 - Ø38

4 Pcs

96 Pcs

70 - 90 cm

Box Barcode
08691913100417



Product Name

IB-1006

Teknik Özellikler

Technical Specifications



KOD
Code
15026

RENK
Color

33x110

monoblock

0,026 m² / pcs
40HC 2644

Ø19 - Ø28

4 Pcs

140 Pcs

70 - 90 cm

Box Barcode
08691913300084





Embrace dry
comfort

Kurutmalıklar
laundry dryer

Product Name
Exclusive

Teknik Özellikler
Technical Specifications



KOD
Code

57061

RENK
Color



0,036 m² / pcs
40HC 2040

2 Pcs

96 Pcs

20 M / 50 kg

Box Barcode
18691913004712



Product Name
**Twingo Lux
Alüminyum**

Teknik Özellikler
Technical Specifications



KOD
Code

57045

RENK
Color



0,078 m² / pcs
40HC 896

Ø16 - Ø8

Plastik Kaplama
Plastic Coating

2 Pcs

54 Pcs

25 M / 15 kg

Box Barcode
08691913570104



Product Name
Twingo Lux

Teknik Özellikler
Technical Specifications

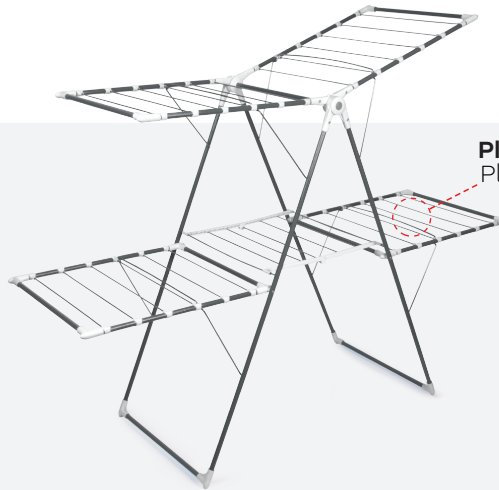

Plastik
Plastic



KOD
Code

57009

RENK
Color



0,078 m² / pcs
40HC 896

Ø16

Plastik - Plastic

2 Pcs

54 Pcs

25 M / 15 kg

Box Barcode
18691913011604



Product Name

Luiza

Teknik Özellikler

Technical Specifications



KOD
Code

57017

RENK
Color



0,056 m² / pcs
40HC 1248



Ø16 - Ø8



4 Pcs



84 Pcs



23,5 M / 18 kg

Box Barcode
18691913011628



Product Name

**Flyby
Alüminyum**

Teknik Özellikler

Technical Specifications



KOD
Code

17026

RENK
Color



0,036 m² / pcs
40HC 2000



Ø19 - Ø7,8



2 Pcs



50 Pcs

20 M / 20 kg



Product Name

Triplex

Teknik Özellikler

Technical Specifications



KOD
Code

17032

RENK
Color



0,023 m² / pcs
40HC 3042



Ø19

Plastik - Plastic



2 Pcs



50 Pcs

16 M / 15 kg

Box Barcode
18691913007911



Product Name
Twingo

Teknik Özellikler
Technical Specifications

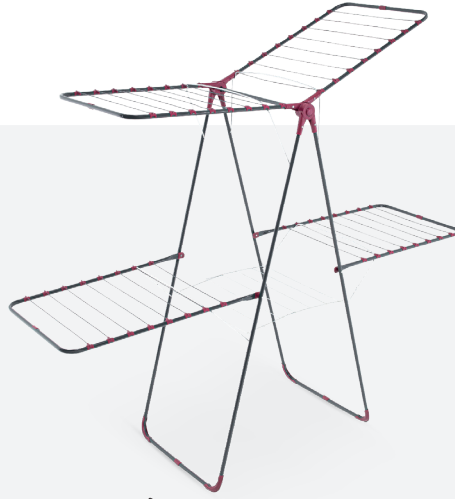

KOD
Code
17008

RENK
Color

0,060 m² / pcs
40HC 1148

Ø16

4 Pcs

84 Pcs

30 M / 20 kg

Box Barcode
08691913170397

8 691913 170083

Product Name
Elvira

Teknik Özellikler
Technical Specifications



KOD
Code
17006

RENK
Color

0,040 m² / pcs
40HC 1746

Ø16 - Ø8

4 Pcs

84 Pcs

16,3 M / 12 kg

Box Barcode
18691913011581

8 691913 201602

Product Name
Majestic

Teknik Özellikler
Technical Specifications



KOD
Code
57005

RENK
Color

0,036 m² / pcs
40HC 2040

10x20 - Ø8

4 Pcs

120 Pcs

19 M / 50 kg

Box Barcode
18691913010133

8 691913 128695

Product Name

Mega Alüminyum

Teknik Özellikler
Technical
Specifications



KOD
Code
57026

RENK
Color

0,052 m³ / pcs
40HC 1344

Ø16 - Ø8

4 Pcs

84 Pcs

17,5 M / 12 kg

Box Barcode
08691913570265

8 691913 201615

Product Name

Almine

Teknik Özellikler
Technical
Specifications

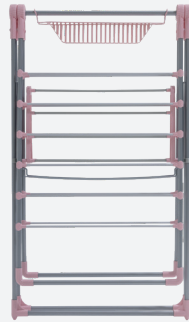

KOD
Code
57004

RENK
Color

0,051 m³ / pcs
40HC 1360

Ø16 - Ø8

4 Pcs

84 Pcs

15,5 M / 12 kg



Box Barcode
08691913150252

8 691913 201626

Product Name

Mega Plast

Teknik Özellikler
Technical
Specifications



KOD
Code
57022
57022-1

RENK
Color

0,050 m³ / pcs
40HC 1400

Ø16

4 Pcs

84 Pcs

17,5 M / 12 kg

Plastik - Plastik

Plastik Kaplama
Plastic Coating

Box Barcode
18691913003401

8 691913 121184
 8 691913 116234

Product Name

Violet

Teknik Özellikler

Technical Specifications



KOD
Code
17042

RENK
Color
Green

0,044 m² / pcs
40HC 1608

Ø16 - Ø8

6 Pcs

72 Pcs

17,5 M / 12 kg



Box Barcode
18691913004668

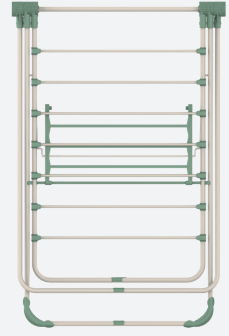

Product Name

Vinela

Teknik Özellikler

Technical Specifications



KOD
Code
17038

RENK
Color
Green

0,036 m² / pcs
40HC 1948

Ø16

4 Pcs

144 Pcs

17,5 M / 15 kg

Box Barcode
18691913004934



Product Name

Avrora

Teknik Özellikler

Technical Specifications



KOD
Code
17009

RENK
Color
Red

0,029 m² / pcs
40HC 2256

Ø16

4 Pcs

144 Pcs

17,5 M / 15 kg



Box Barcode
18691913011512



Product Name

Livia

Teknik Özellikler

Technical Specifications



KOD
Code

17040

RENK
Color



0,048 m² / pcs
40HC 1445



Ø16



5 Pcs



60 Pcs



16,7 M / 14 kg

Box Barcode
1869191301718



8 691913 115237

Product Name

**Mina
Large**

Teknik Özellikler

Technical Specifications



KOD
Code

17019

RENK
Color



0,061 m² / pcs
40HC 1152



Ø16



4 Pcs



48 Pcs



20 M / 17,5 kg

Box Barcode
08691913150375



8 691913 401101

Product Name

**Isabella
Sepetli +**

Teknik Özellikler

Technical Specifications

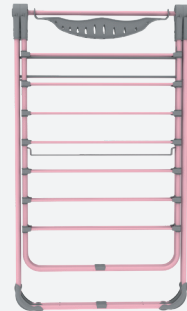

KOD
Code

17036

RENK
Color



0,044 m² / pcs
40HC 1608



Ø16 - Ø8



6 Pcs



72 Pcs



14,3 M / 12 kg



Box Barcode
18691913011819



8 691913 201604

Product Name
Isabella +

Teknik Özellikler
Technical Specifications



KOD
Code
17034

RENK
Color

0,044 m² / pcs
40HC 1608

Ø16 - Ø8

6 Pcs

72 Pcs

14,3 M / 12 kg

Box Barcode
08691913150238

8 691913 201657

Product Name
Mina

Teknik Özellikler
Technical Specifications



KOD
Code
17012

RENK
Color

0,035 m² / pcs
40HC 1986

Ø16

6 Pcs

72 Pcs

19 M / 15 kg



Box Barcode
18691913011598

8 691913 401084

Product Name
Mega Present

Teknik Özellikler
Technical Specifications

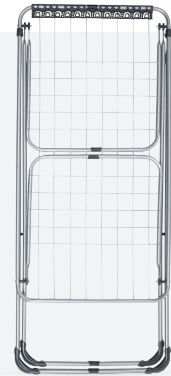

KOD
Code
17002

RENK
Color

0,029 m² / pcs
40HC 2400

Ø16

6 Pcs

108 Pcs

17,5 M / 15 kg



Box Barcode
18691913011550

8 691913 500170

Product Name
Looma

Teknik Özellikler
Technical Specifications

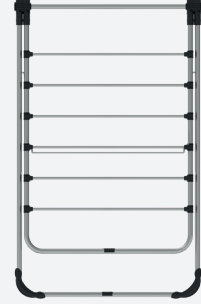

KOD
Code
17041

RENK
Color
●

0,041 m² / pcs
40HC 1750

Ø8 - Ø16

6 Pcs

72 Pcs

11 M / 12 kg

Box Barcode
18691913004521

8 691913 113547

Product Name
Star

Teknik Özellikler
Technical Specifications



KOD
Code
17005

RENK
Color
●

0,022 m² / pcs
40HC 2880

Ø16 - Ø14 - Ø12

8 Pcs

120 Pcs

17,5 M / 12 kg



Box Barcode
18691913011574

8 691913 700280

Product Name
Uzay Sepetli

Teknik Özellikler
Technical Specifications



KOD
Code
17004

RENK
Color
●

0,027 m² / pcs
40HC 2624

Ø16

8 Pcs

96 Pcs

19 M / 15 kg



Box Barcode
18691913011567

8 691913 401026

Product Name

Priya

Teknik Özellikler

Technical Specifications

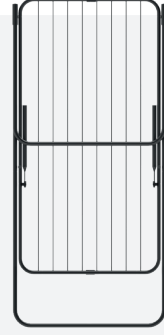

KOD
Code

17044

RENK
Color



0,027 m² / pcs
40HC 2624



Ø16



6 Pcs



96 Pcs



12,5 M / 10 kg

Box Barcode

18691913006945



8 4691913 401026

Product Name

**Dirsekli
Balkon**

Teknik Özellikler

Technical Specifications

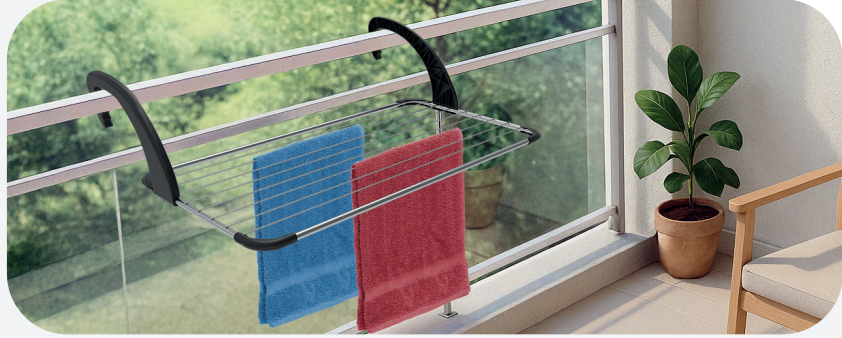

KOD
Code

17011

RENK
Color



0,015 m² / pcs
40HC 4660



Ø16



10 Pcs



180 Pcs



11 M / 5 kg

Box Barcode

08691913570203



8 691913 701003

Product Name

Petek

Teknik Özellikler

Technical Specifications



KOD
Code

17016

RENK
Color



0,003 m² / pcs
40HC 20310



Ø12



10 Pcs



550 Pcs



3,5 M / 3 kg

Box Barcode

08691913570210



8 691913 701027

HousePlus

Product Name

LD-2001

Teknik Özellikler

Technical Specifications

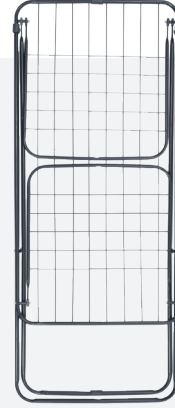
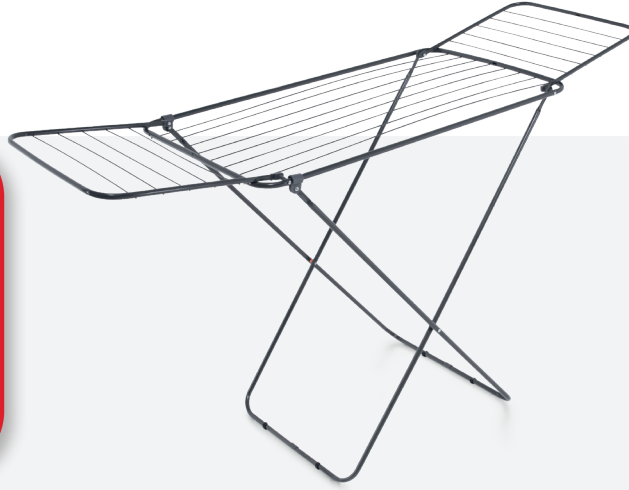

KOD
Code

17010

RENK
Color



0,022 m² / pcs
40HC 2408

Ø14 - Ø14 - Ø12

8 Pcs

120 Pcs

17,5 M / 12 kg

Box Barcode
08691913201008



HousePlus

Product Name

LD-2004

Teknik Özellikler

Technical Specifications



KOD
Code

17029

RENK
Color



0,021 m² / pcs
40HC 3264

Ø14 - Ø14 - Ø12

8 Pcs

120 Pcs

17 M / 10 kg

Box Barcode
18691913003432



HousePlus

Product Name

LD-2007

Teknik Özellikler

Technical Specifications



KOD
Code

17043

RENK
Color



0,023 m² / pcs
40HC 3018

Ø14 - Ø12

6 Pcs

108 Pcs

18,5 M / 15 kg

Box Barcode
18691913005238



HousePlus

Product Name

Fly

Teknik Özellikler

Technical Specifications



KOD
Code

17106

RENK
Color



0,019 m² / pcs
40HC 3180

Ø14

10 Pcs

120 Pcs

11,5 M / 7 kg

Box Barcode
08691913702314







*always
higher*

Product Name

G1200

Kod Code		m ³ Cbm	Barkod Barcode	
11002	2	0,043	8691913101100	60
11003	3	0,052	8691913101032	79
11004	4	0,062	8691913101049	79
11005	5	0,073	8691913101056	80
11006	6	0,085	8691913101063	60
11007	7	0,096	8691913101070	45
11008	8	0,110	8691913101087	45
11009	9	0,121	8691913101094	45



120 kg
Taşıma Kapasitesi
Weight Capacity

"İnsan ve Çevre Dostu Merdiven
Siyanür ve Krom+6 içermeyen Alkali Çinko Kaplama."



Product Name

Comfort

Kod Code		m ³ Cbm	Barkod Barcode	
51203	3	0,085	8691913128084	45
51204	4	0,099	8691913128091	45
51205	5	0,113	8691913128107	45
51206	6	0,131	8691913128114	45
51207	7	0,151	8691913128121	45
51208	8	0,168	8691913128138	45
51209	9	0,188	8691913128145	45



120 kg
Taşıma Kapasitesi
Weight Capacity



Product Name

Riser

Kod Code		m ³ Cbm	Barkod Barcode	
51303	3	0,058	8691913128152	60
51304	4	0,073	8691913128169	80
51305	5	0,089	8691913128176	80
51306	6	0,106	8691913128183	60
51307	7	0,123	8691913128190	45





150 kg
Taşıma Kapasitesi
Weight Capacity



Product Name

Çift Çıkışlı

Kod Code		m ³ Cbm	Barkod Barcode	
12503	3+3	0,044	8691913001035	39
12504	4+4	0,059	8691913001042	39
12505	5+5	0,077	8691913001059	39
12506	6+6	0,094	8691913001066	39
12507	7+7	0,114	8691913001073	39
12508	8+8	0,127	8691913001080	39
12509	9+9	0,150	8691913001097	39



"İnsan ve Çevre Dostu Merdiven
Siyanür ve Krom+6 içermeyen
Alkali Çinko Kaplama."

120 kg
Taşıma Kapasitesi
Weight Capacity



Product Name

Class



Kod Code		m ³ Cbm	Barkod Barcode Box Barcode	
13002	2	0,023	8691913000137 18691913011635	192
13003	3	0,030	8691913000144 18691913011642	144
13004	4	0,037	8691913400098 18691913011659	112

Adet / Qty 4 Ad / Pcs

150 kg
Taşıma Kapasitesi
Weight CapacityRenk
Color 

Product Name



Stepla

Kod Code		m ³ Cbm	Barkod Barcode	
51402	2	0,108	8691913120316	60
51403	3	0,103	8691913120323	84
51404	4	0,086	8691913120347	64
51405	5	0,101	8691913120361	30

150 kg
Taşıma Kapasitesi
Weight Capacity

Product Name

Çift Çıkışlı Alüminyum

Kod Code		m ³ Cbm	Barkod Barcode	
51085	3+3	0,046	8691913108529	39
51086	4+4	0,064	8691913108536	39
51087	5+5	0,082	8691913108543	39
51088	6+6	0,101	8691913108550	39
51089	7+7	0,122	8691913108567	39
51090	8+8	0,143	8691913108574	39
51091	9+9	0,166	8691913108581	39



150 kg
Taşıma Kapasitesi
Weight Capacity

Alüminyum
Aluminum

Product Name

Akrobat

Kod Code		m ³ Cbm	Barkod Barcode
51064	12	0,099	8691913700174
51065	16	0,128	8691913700396
51066	20	0,156	8691913700419



150 kg
Taşıma Kapasitesi
Weight Capacity

Alüminyum
Aluminum

Product Name

İki Parçalı Sürgülü

Double Part Extension
Aluminum Ladder

Kod Code		m ³ Cbm	Barkod Barcode
51009	2 x 2 = 4 m.	0,100	8691913700594
51011	3 x 2 = 6 m.	0,150	8691913700617
51013	4 x 2 = 8 m.	0,200	8691913700631
51015	5 x 2 = 10 m.	0,250	8691913700655

Alüminyum
Aluminum

150 kg
Taşıma Kapasitesi
Weight Capacity



Product Name

İki Parçalı A Tipi SürgülüA Type Double Part
Extension Aluminum Ladder

Kod Code		m ³ Cbm	Barkod Barcode
51042	2 x 2 = 4 + 1 = 5 m.	0,100	8691913700938
51044	3 x 2 = 6 + 1 = 7 m.	0,150	8691913700952
51046	4 x 2 = 8 + 1 = 9 m.	0,200	8691913700976
51048	5 x 2 = 10 + 1 = 11 m.	0,250	8691913700990

Alüminyum
Aluminum**150 kg**
Taşıma Kapasitesi
Weight Capacity

Product Name

Üç Parçalı A Tipi SürgülüA Type Triple Part
Extension Aluminum Ladder

Kod Code		m ³ Cbm	Barkod Barcode
51081	2 x 3 = 6 + 1 = 7 m.	0,160	8691913701348
51051	3 x 3 = 9 + 1 = 10 m.	0,240	8691913700044
51053	4 x 3 = 12 + 1 = 13 m.	0,320	8691913700068
51055	5 x 3 = 15 + 1 = 16 m.	0,400	8691913700082

Alüminyum
Aluminum**150 kg**
Taşıma Kapasitesi
Weight Capacity

Product Name

İskele

Scaffold Aluminum Ladder

Kod Code		m ³ Cbm	Barkod Barcode
51110	6 m	0,604	8691913510964
51112	8 m	0,781	8691913510971

Alüminyum
Aluminum**150 kg**
Taşıma Kapasitesi
Weight Capacity

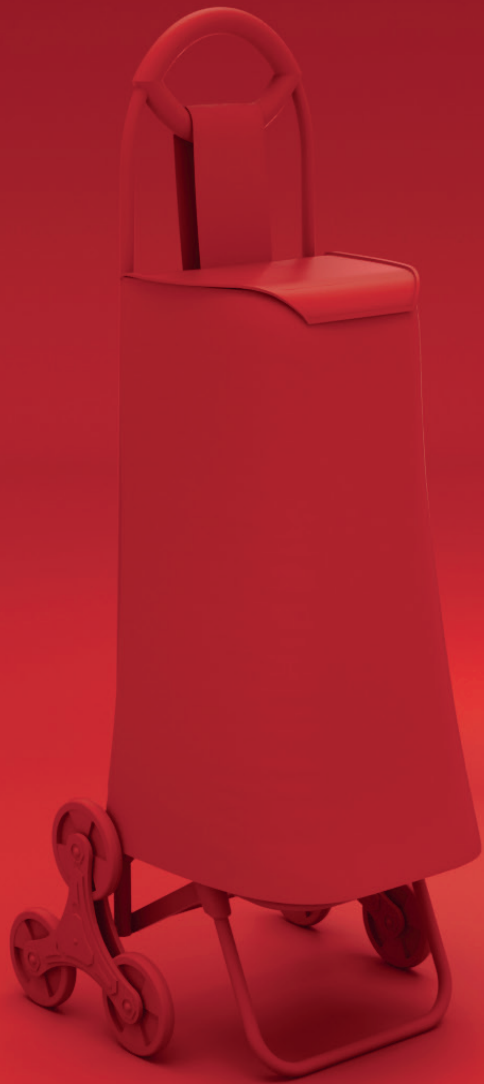

modern **stylish
ergonomic**

Product Name
403 C

Teknik Özellikler
Technical Specifications



Eva Teker
Eva Wheel

KOD
Code
58030



0,030 m³ /pcs



6 pcs



180 pcs



39
LT



25
KG

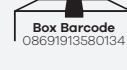

Box Barcode
08691913580134



8 691913 800270

Product Name
406 B

Teknik Özellikler
Technical Specifications



KOD
Code
58038



23 cm



0,021 m³ /pcs



4 pcs



320 pcs



39
LT



25
KG

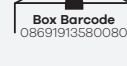

Box Barcode
08691913580080



8 691913 800263

Product Name
405 B

Teknik Özellikler
Technical Specifications



KOD
Code
58036



19,5 cm



0,013 m³ /pcs



4 pcs



320 pcs



39
LT



25
KG

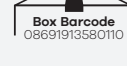

Box Barcode
08691913580110



8 691913 800256

Product Name
402 B

Teknik Özellikler
Technical Specifications



KOD
Code
58015

17,5 cm

0,014 m³ / pcs

4 pcs

320 pcs

36 LT

25 KG

Box Barcode
08691913580059

8 691913 800225

Product Name
403 B

Teknik Özellikler
Technical Specifications



KOD
Code
58021

0,014 m³ / pcs

0,014 m³ / pcs

4 pcs

320 pcs

28 LT

25 KG

Box Barcode
08691913580028

8 691913 800027

Product Name
401 F

Teknik Özellikler
Technical Specifications



KOD
Code
58009

16,5 cm

0,014 m³ / pcs

4 pcs

320 pcs

34 LT

25 KG

Box Barcode
18691913009885

8 691913 128466

Product Name
401 K

Teknik Özellikler
Technical Specifications



KOD
Code
58096

15 cm

0,014 m³ /pcs

4 pcs

352 pcs

**34
LT**

**25
KG**

Box Barcode
18631913004682

8 691913 113073

Product Name
**Jumbo
Extra**

Teknik Özellikler
Technical Specifications



KOD
Code
58010

17,5 cm

0,028 m³ /pcs

**6 pcs
320 pcs**

**70
LT**

**30
KG**

8 691913 402078

Product Name
**Klasik
Extra**

Teknik Özellikler
Technical Specifications



KOD
Code
58016

17,5 cm

0,028 m³ /pcs

320 pcs

**60
LT**

**25
KG**

8 691913 999936

Product Name

Klasik New

Teknik Özellikler

Technical Specifications



KOD

Code

58027



15 cm



0,026 m³ /pcs



6 Pcs
320 pcs

60
LT

25
KG



8 691913 800034

Product Name

Eko Mini

Teknik Özellikler

Technical Specifications



KOD

Code

58028



16,5 cm



0,026 m³ /pcs



6 Pcs
174 pcs

48
LT

20
KG



8 691913 401330

Product Name

Alışveriş Çantası

Teknik Özellikler

Technical Specifications



KOD

Code

58100



9 cm



0,003 m³ /pcs



12 pcs



600 pcs

35
LT

10
KG

Box Barcode

08691913580097



8 691913 610074

Teker
Wheel
58078

Eva
Koli / Box : 80 Adet/ Pcs

Kullanılan Araç Kodu:
Suitable Car Code:
402A - 407A - 408A



Teker
Wheel
58087

Plastik / Plastic
Koli / Box : 80 Adet/ Pcs

Kullanılan Araç Kodu:
Suitable Car Code:
401B - 402B - 402C
402D - 402H



Teker
Wheel
58082

Eva
Koli / Box : 160 Adet/ Pcs

Kullanılan Araç Kodu:
Suitable Car Code:
401A



Teker
Wheel
58080

Plastik / Plastic
Koli / Box : 108 Adet/ Pcs

Kullanılan Araç Kodu:
Suitable Car Code:
Klasik New



Teker
Wheel
58024

Plastik / Plastic
Koli / Box : 108 Adet/ Pcs

Kullanılan Araç Kodu:
Suitable Car Code:
Eko Mini



Teker
Wheel
58079

Plastik / Plastic
Koli / Box : 80 Adet/ Pcs

Kullanılan Araç Kodu:
Suitable Car Code:
403B



Teker
Wheel
58077

Plastik / Plastic
Koli / Box : 72 Adet/ Pcs

Kullanılan Araç Kodu:
Suitable Car Code:
Klasik Eko - 405B



Teker
Wheel
58076

Plastik / Plastic
Koli / Box : 48 Adet/ Pcs

Kullanılan Araç Kodu:
Suitable Car Code:
Delux - 406B



Teker
Wheel
58084

**Plastik - Sac
Plastik - Sheet Metal**
Koli / Box : 48 Adet/ Pcs
Kullanılan Araç Kodu:
Suitable Car Code:
Klasik Extra Jumbo



Teker
Wheel
58023

Plastik / Plastic
Koli / Box : 108 Adet/ Pcs

Kullanılan Araç Kodu:
Suitable Car Code:
401D - 401F - 401H



Teker
Wheel
58083

Eva
Koli / Box

Kullanılan Araç Kodu:
Suitable Car Code:
403A - 403C



Çanta
Bag

58091 - Küçük Boy Elyaf Çanta
58092 - Büyük Boy Elyaf Çanta
58093 - Jumbo Boy Elyaf Çanta



Çanta
Bag

58094 - Denye Kumaş Çanta



Alışveriş Arabası Şirink
Shopping Trolley Wrapping





*elegant
lines*

Product Name

Shore Ayaklı Askılık

Shore Clotfing
Garment Racks

Teknik Özellikler
Technical
Specifications



KOD
Code

18003

RENK
Color



0,009 m³ /pcs



6 pcs



96 pcs



8 691913 114520



Box Barcode
18691913015947



Product Name

Shore Duo Ayaklı Askılık

Shore Duo Clotfing
Garment Racks

Teknik Özellikler
Technical
Specifications



KOD
Code

18004

RENK
Color



0,012 m³ /pcs



6 pcs



108 pcs



8 691913 114537



Box Barcode
18691913015954

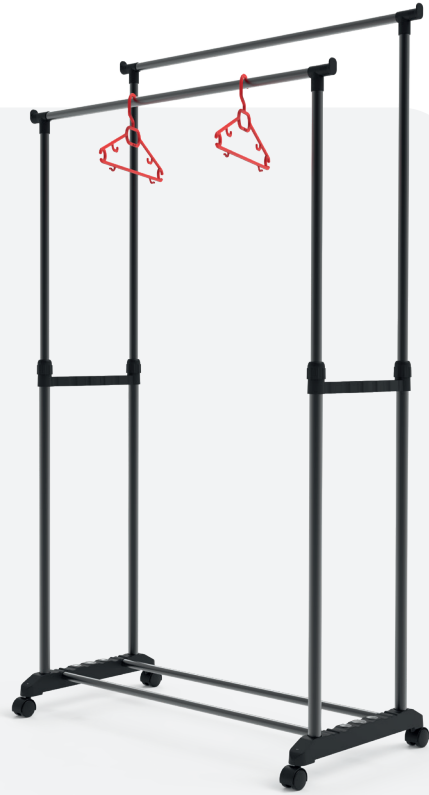
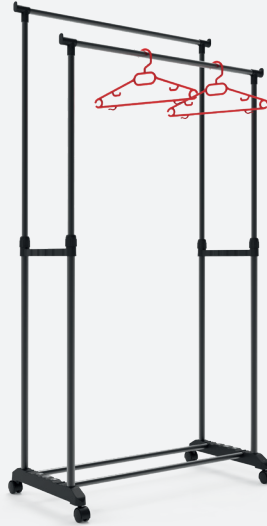

Product Name
Lobby Ayaklı Askı
Coat Hanger

Teknik Özellikler
Technical Specifications

KOD
Code
18002-1

RENK
Color

0,020 m³ / pcs

4 pcs

100 pcs



Box Barcode
08691913180044



Product Name
Lenita Pratik Sehpa
Folding Tray

Teknik Özellikler
Technical Specifications

KOD
Code
19001

0,010 m³ / pcs

8 pcs

480 pcs



Box Barcode
08691913403259



HousePlus
Product Name
Portmanto
Coat Hanger

Teknik Özellikler
Technical Specifications

KOD
Code
61004

RENK
Color

0,011 m³ / pcs

10 pcs

150 pcs



Box Barcode
18691913011291

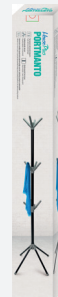

Termal Ütü Masası Kılıfı Thermal & Non-Burn Cover

Code: 54012
Cbm: 0.006 m³ / pcs
Barcode: 8691913501214
Box Barcode:
08691915401208

Keçe / Felt

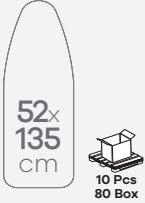

Premium Ütü Masası Kılıfı Premium Ironing Board Cover

Soft Pembe / Soft Pink
Code: 54025
Cbm: 0.008 m³ / pcs
Barcode: 8691913540121

Keçe / Felt

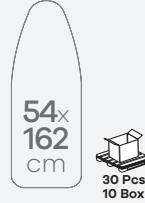

Medium Ütü Masası Kılıfı Medium Ironing Board Cover

Code: 54001
Cbm: 0.004 m³ / pcs
Barcode: 8691913130131
Box Barcode:
18691913002497

Keçe / Felt

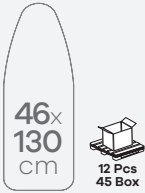

Large Ütü Masası Kılıfı Large Ironing Board Cover

Code: 54002
Cbm: 0.004 m³ / pcs
Barcode: 8691913700372
Box Barcode:
18691913002503

Keçe / Felt

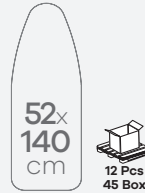

Small Ütü Masası Kılıfı Medium Ironing Board Cover

Code: 54007
Cbm: 0.002 m³ / pcs
Barcode: 8691913130209
Box Barcode:
18691913002534

Sünger / Foam

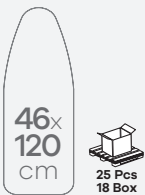

Medium Ütü Masası Kılıfı Medium Ironing Board Cover

Code: 54004
Cbm: 0.002 m³ / pcs
Barcode: 8690078010012
Box Barcode:
08691913002438

Sünger / Foam

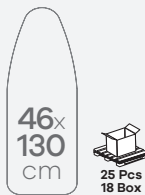

Large Ütü Masası Kılıfı Medium Ironing Board Cover

Code: 54003
Cbm: 0.002 m³ / pcs
Barcode:
8690078010029
Box Barcode:
08691913002445

Sünger / Foam



Product Name
**Tek Katlı
Tabaklık**
Dish Drainer With
Cutlery Holder

Teknik Özellikler
Technical
Specifications



- 71107
- 71106
- 71101
- 71110

10 Pcs
Cbm: 0,021 m³ / Pcs
Barcode: 8691913200094
Box Barcode: 08691913203545
Palet / Pallet: 240 Adet / Pcs



Product Name
**İki Katlı
Tabaklık**
Two Tier Dish Drainer
With Cutlery Holder

Teknik Özellikler
Technical
Specifications



- 71109
- 71108
- 71103
- 71112

4 Pcs
Cbm: 0,021 m³ / Pcs
Barcode: 8691913200087
Box Barcode: 08691913203538
Palet / Pallet: 140 Adet / Pcs



Product Name
**İki Katlı
Şampuanlık**
Two Layer Shampoo
Holder

Teknik Özellikler
Technical
Specifications



- 71310
- 71309

12 Pcs
Cbm: 0,006 m³ / Pcs
Barcode: 8691913200070
Box Barcode: 08691913203521
Palet / Pallet: 864 Adet / Pcs

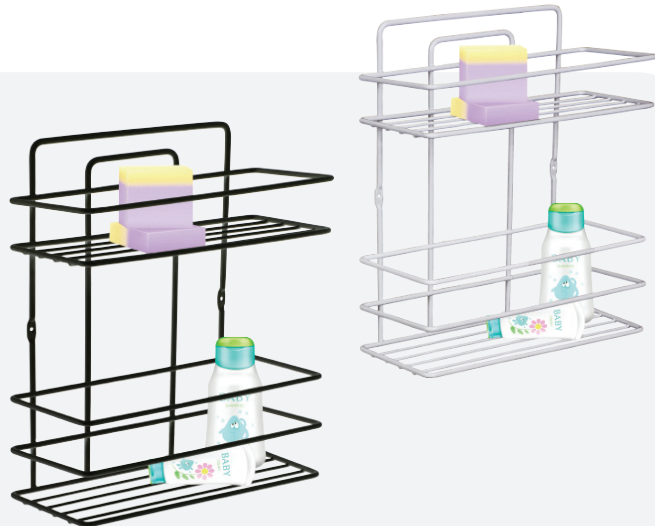

Product Name

Üç Katlı Şampuanlık

Three Layer Shampoo
Holder

Teknik Özellikler

Technical
Specifications



12 Pcs

Cbm: 0,010 m³ / Pcs

Barcode: 8691913200056

Box Barcode: 08691913203606

Palet / Pallet: 576 Adet / Pcs



71308



71307



Product Name

İki Katlı Banyo Köşeliği

Shower Two Tier
Corner Caddy

Code: 71306 - 12 Pcs

Cbm: 0,007 m³ / Pcs

Barcode: 8691913200032

Box Barcode:

08691913203583

Palet / Pallet: 672 Adet / Pcs



71305



71306



71302

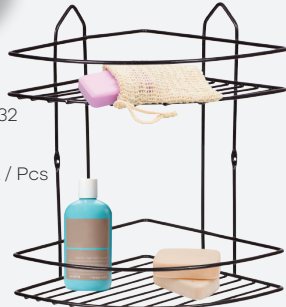

Product Name

Üç Katlı Banyo Köşeliği

Shower Triple
Corner Caddy

Code: 71304 - 12 Pcs

Cbm: 0,014 m³ / Pcs

Barcode: 8691913200018

Box Barcode:

08691913203569

Palet / Pallet: 384 Adet / Pcs



71303



71304



71301



71311



Product Name

WC Ayaklı Kağıtlık

WC Stand Paper
Holder

Teknik Özellikler

Technical
Specifications



Code: 71312 - 12 Pcs

Cbm: 0,010 m³ / Pcs

Barcode: 8691913119297

Box Barcode: 18691913013110





Strong and stylish

Kamp Ürünleri
Camping Products

Product Name

Kamp Sandalyesi Deniz

Camping Chair Sea

Teknik Özellikler

Technical Specifications



KOD
Code

40000-1



0.012 m³ /pcs



6 pcs



288 pcs



8 691913 116542

Box Barcode

18691913000417



Product Name

Kamp Sandalyesi Doğa

Camping Chair Nature

Teknik Özellikler

Technical Specifications



KOD
Code

40000-2



0.012 m³ /pcs



6 pcs



288 pcs



8 691913 118580

Box Barcode

18691913000479



Product Name

Kamp Sandalyesi Alev

Camping Chair Flame

Teknik Özellikler

Technical Specifications



KOD
Code

40000-3



0.012 m³ /pcs



6 pcs



288 pcs



8 691913 118702

Box Barcode

18691913000653



Yeni

Product Name

Kamp Sandalyesi

Camping Chair

Teknik Özellikler

Technical Specifications



KOD
Code

40003-2



0.012 m³ /pcs



6 pcs



288 pcs



Box Barcode
18691913011505



Yeni

Product Name

Kamp Sandalyesi

Camping Chair

Teknik Özellikler

Technical Specifications



KOD
Code

40003-1



0.012 m³ /pcs



6 pcs



288 pcs



Box Barcode
18691913011468



Yeni

Product Name

Kamp Sandalyesi

Camping Chair

Teknik Özellikler

Technical Specifications



KOD
Code

40003-3



0.012 m³ /pcs



6 pcs



288 pcs



Box Barcode
18691913011529



Product Name
Şezlong Siyah
Sun Lounger Black

Teknik Özellikler
Technical Specifications



KOD
Code

40001



0,010 m³ /pcs



3 pcs



108 pcs



Box Barcode
18691913002817



Product Name
Şezlong Gri
Sun Lounger Gray

Teknik Özellikler
Technical Specifications



KOD
Code

40001-1



0,010 m³ /pcs



3 pcs



108 pcs



Box Barcode
18691913002831



Product Name
Şezlong Mavi
Sun Lounger Blue

Teknik Özellikler
Technical Specifications



KOD
Code

40001-2



0,010 m³ /pcs



3 pcs



108 pcs



Box Barcode
18691913002848



evelux

another
thing

Product Name

Sempati

Tabure / Stool

Code

EVL20001

Cbm

0,007 m³

Ürün Ebadı

31,6 x 31,6 x 32 cm

Ambalaj Şekli

Poşet / 20 Adet

Palet

20 Paket / Pack

Ambalaj Ölçüsü

31,6 x 31,6 x 135 cm

Palet / Pallet

640 Adet / Pcs



Product Name

Modern

Tabure / Stool

Code

EVL20002

Cbm

0,007 m³

Ürün Ebadı

33,7 x 33,7 x 37,5 cm

Ambalaj Şekli

Poşet / 20 Adet

Palet

20 Paket / Pack

Ambalaj Ölçüsü

33,7 x 33,7 x 135 cm

Palet / Pallet

640 Adet / Pcs



Product Name

Fantazi

Tabure / Stool

Code

EVL20003

Cbm

0,013 m³

Ürün Ebadı

36,5 x 36,5 x 44 cm

Ambalaj Şekli

Poşet / 12 Adet

Palet

15 Paket / Pack

Ambalaj Ölçüsü

36,5 x 36,5 x 116 cm

Palet / Pallet

384 Adet / Pcs



Product Name

Meram

Tabure / Stool

Code

EVL20004

Cbm

0,005 m³

Ürün Ebadı

32 x 32 x 32 cm

Ambalaj Şekli

Poşet / 20 Adet

Palet

25 Paket / Pack

Ambalaj Ölçüsü

32 x 32 x 93 cm

Palet / Pallet

640 Adet / Pcs



Product Name

Karatay

Tabure / Stool

Code

EVL20005

Cbm

0,006 m³

Ürün Ebadı

34 x 34 x 37,5 cm

Ambalaj Şekli

Poşet / 20 Adet

Palet

20 Paket / Pack

Ambalaj Ölçüsü

34 x 34 x 104 cm

Palet / Pallet

640 Adet / Pcs



Product Name

Selçuklu

Tabure / Stool

Code

EVL20006

Cbm

0,008 m³

Ürün Ebadı

37 x 37 x 45 cm

Ambalaj Şekli

Poşet / 20 Adet

Palet

18 Paket / Pack

Ambalaj Ölçüsü

37 x 37 x 115 cm

Palet / Pallet

640 Adet / Pcs



Product Name
Modüler Rahle
Lectern

Teknik Özellikler
Technical
Specifications

Code	: EVL21001
Cbm	: 0,010 m ³
Box Barcode	: 08691913600061
Ürün Ebadı	: 50,6 x 34 x 43,5 cm
Ambalaj Şekli	: Koli / 12 Adet
Palet	: 20 Koli / Box
Ambalaj Ölçüsü	: 41 x 62 x 48 cm
Palet / Pallet	: 480 Adet / Pcs



Product Name
Pratik Rahle
Mini Lectern

Teknik Özellikler
Technical
Specifications

Code	: EVL21003
Cbm	: 0,0016 m ³
Box Barcode	: 08691913600085
Ürün Ebadı	: 32 x 22 x 18,5 cm
Ambalaj Şekli	: Koli / 50 Adet
Palet	: 18 Koli / Box
Ambalaj Ölçüsü	: 30 x 60 x 50,5 cm
Palet / Pallet	: 1440 Adet / Pcs

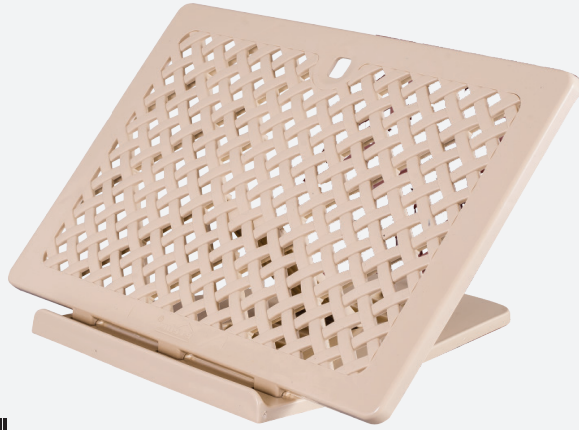

Product Name
Sufle Rahle
Lectern

Teknik Özellikler
Technical
Specifications

Code	: EVL21002
Cbm	: 0,016 m ³
Box Barcode	: 08691913600078
Ürün Ebadı	: 50,6 x 34 x 43,5 cm
Ambalaj Şekli	: Koli / 12 Adet
Palet	: 24 Koli / Box
Ambalaj Ölçüsü	: 37 x 52 x 105 cm
Palet / Pallet	: 288 Adet / Pcs



Product Name
Teleskopik Çamaşır Sepeti
Collapsible Laundry Basket

Code : EVL25100
Cbm : 0,015 m³
Box Barcode : 18691913016715
Ürün Ebadı Açık : 35,5 x 33,7
Ürün Ebadı Kapalı : 35,5 x 11,3
Ambalaj Şekli : Koli / 4 Adet
Ambalaj Ölçüsü : 71 x 36,5 x 23,5 cm
Palet / Pallet : 256 Adet / Pcs



Product Name
Pratik Geri Dönüşüm Çöp Standı
Practical Recycling Waste Stand

Code : EVL25300
Cbm : 0,021 m³
Box Barcode : 18691913003753
Ürün Ebadı Açık : 37 x 69 x 83,5 cm
Ürün Ebadı Kapalı : 5 x 87 x 69 cm
Ambalaj Şekli : Koli / 10 Adet
Palet : 24 Koli / Box
Ambalaj Ölçüsü : 33 x 87,5 x 71,5 cm
Palet / Pallet : 120 Adet / Pcs



Product Name
Esnek Hasır Paspas
Fleivable Plastic Mats

Code : EVL23001
Cbm : 0,0009 m³
Box Barcode : 08691913600184
Ürün Ebadı : 33.3 x 33.3 x 1.35 cm
Ambalaj Şekli : Koli / 54 Adet
Palet : 1728 Adet / Pcs
Ambalaj Ölçüsü : 35 x 35 x 38 cm

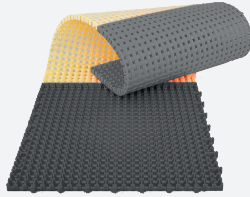

Product Name
Dekor Hasır Paspas
Decor Plastic Mats

Code : EVL23002
Cbm : 0,0009 m³
Box Barcode : 08691913600191
Ürün Ebadı : 33.3 x 33.3 x 1.25 cm
Ambalaj Şekli : Koli / 54 Adet
Palet : 1728 Adet / Pcs
Ambalaj Ölçüsü : 36 x 36 x 49 cm

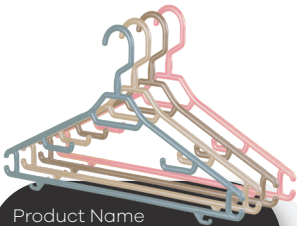
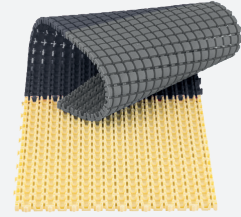
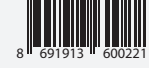

Product Name
Eko Elbise Askısı
Eco Clothes Hanger

Code : EVL24001
Cbm : 0,0006 m³
Box Barcode : 08691913600207
Ürün Ebadı : 37 x 21 x 0,6 cm
Ambalaj Şekli : Koli / 6 x 24 = 144 Adet
Palet : 1200 Adet / Pcs
Ambalaj Ölçüsü : 40 x 56 x 39 cm



Product Name
Döner Başlıklı Askı
Clothes Hanger With 360

Code : EVL24002
Cbm : 0,0006 m³
Box Barcode : 08691913600214
Ürün Ebadı : 105 x 43 x 24 cm
Ambalaj Şekli : Koli / 6 x 24 = 144 Adet
Palet : 1200 Adet / Pcs
Ambalaj Ölçüsü : 40 x 56 x 39 cm



Product Name
Kristal Askı
Cyrstal Clothes Hanger

Code : EVL24003
Cbm : 0,0006 m³
Box Barcode : 08691913600221
Ürün Ebadı : 0,8 x 43 x 24,5 cm
Ambalaj Şekli : Koli / 6 x 24 = 144 Adet
Palet : 1200 Adet / Pcs
Ambalaj Ölçüsü : 40 x 56 x 39 cm



Product Name
Novel Askı
Novel Clothes Hanger

Code : EVL24004
Cbm : 0,0006 m³
Box Barcode : 08691913600238
Ürün Ebadı : 38 x 21,5 x 12,5 cm
Ambalaj Şekli : Koli / 6 x 40 = 240 Adet
Palet : 2000 Adet / Pcs
Ambalaj Ölçüsü : 40 x 56 x 38 cm



23x37 cm(9 mm)

**Kesim Panosu No: 1**

Professional Chopping Board

Code : EVL22003
Cbm : 0,0013 m³
Box Barcode : 08691913600122
Ürün Ebadı : 37 x 23 x 0.9 cm
Ambalaj Şekli : 1732 Adet / Pcs
Palet : 800 Adet / Pcs
Ambalaj Ölçüsü : 30 x 45 x 19 cm



8 691913 600153

27x44 cm(9 mm)

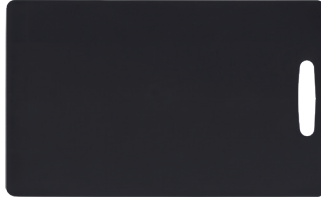
**Kesim Panosu No: 3**

Professional Chopping Board

Code : EVL22004
Cbm : 0,0013 m³
Box Barcode : 08691913600139
Ürün Ebadı : 44 x 27 x 0.9 cm
Ambalaj Şekli : 1732 Adet / Pcs
Palet : 800 Adet / Pcs
Ambalaj Ölçüsü : 30 x 45 x 19 cm



8 691913 600160

29x39 cm (5,5 mm)

**Kesim Panosu No: 4**

Professional Chopping Board

Code : EVL22005
Cbm : 0,0011 m³
Box Barcode : 08691913600146
Ürün Ebadı : 39 x 29 x 0.55 cm
Ambalaj Şekli : Koli / 25 Adet
Palet : 1000 Adet / Pcs
Ambalaj Ölçüsü : 30 x 45 x 19 cm



8 691913 600177

Product Name Kesim Panosu No: 5 - 6

Professional Chopping Board

Eko 23x37 cm(5 mm)

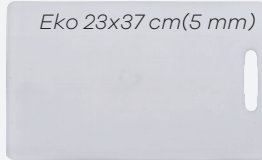

Eko 25x41 cm(5 mm)

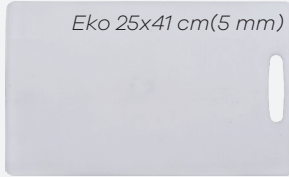

Code : EVL22009
Cbm : 0,0008 m³
Box Barcode : 18691913003548
Ürün Ebadı : 37 x 23 x 0.5 cm
Ambalaj Şekli : Koli / 17 + 17 = 34 Adet
Palet : 1360 Adet / Pcs
Ambalaj Ölçüsü : 30 x 45 x 19,5 cm



8 691913 121337

Product Name Castle Saksı

Professional Chopping Board



Code : EVL25005
Cbm : 0,0008 m³
Box Barcode : 18691913010751
Ürün Ebadı : 9 x 17 x 18,40 cm
Ambalaj Şekli : Koli / 54 Adet
Palet : 2106 Adet / Pcs
Ambalaj Ölçüsü : 52 x 52 x 48,5 cm



8 691913 122778

RENK
Color
● ●**Product Name Harmoni Elbise Askısı**

Harmony Clothes Hanger



Code : EVL24008
Cbm : 0,001 m³
Box Barcode : 18691913016333
Ambalaj Şekli : Koli / 6x20 = 120 Adet
Palet : 2000 Adet / Pcs
Ambalaj Ölçüsü : 46 x 43 x 39 cm



8 691913 118030

Product Name Temizlik Kovası

Cleaning Bucket with Wringer



Code : EVL25001
Cbm : 0,006 m³
Box Barcode : 08691913600245
Ürün Ebadı : 38 x 27 x 24,5 cm
Ambalaj Şekli : Koli / 20 Adet
Palet : 800 Adet / Pcs
Ambalaj Ölçüsü : 39 x 58 x 52,5 cm



8 691913 600276

Minimum Order Quantity
Minimum Sipariş Adeti
MOQ1000



Product Name

Irina

Teknik Özellikler

Technical Specifications

Minimum Order Quantity

Minimum Sipariş Adeti

MOQ1000

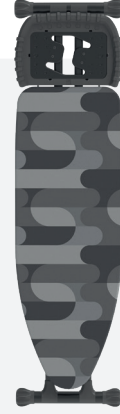

KOD
Code
14007

RENK
Color
●

43x124

monoblock

0,070 m² /pcs
40HC 994



20x35 - Ø51

2 Pcs

72 Pcs

76 - 96 cm

Box Barcode
18691913016401

8 691913 118108

Product Name

Adriana

Teknik Özellikler

Technical Specifications

Minimum Order Quantity

Minimum Sipariş Adeti

MOQ1000



KOD
Code
14008

RENK
Color
●

45x125

perfore/mesh

0,060 m² /pcs
40HC 1168



Ø25 - Ø51

2 Pcs

72 Pcs

78 - 101 cm

Box Barcode
18691913017491

8 691913 115619

Product Name

Valentina

Teknik Özellikler

Technical Specifications

Minimum Order Quantity

Minimum Sipariş Adeti

MOQ1000



KOD
Code
15029

RENK
Color
●

40x120

monoblock

0,041 m² /pcs
40HC 1704



Ø21 - Ø38

4 Pcs

96 Pcs

74 - 95 cm

Box Barcode
18691913002688

8 691913 112724

Product Name

Avila

Teknik Özellikler

Technical Specifications

Minimum Order Quantity

Minimum Sipariş Adeti

MOQ1000

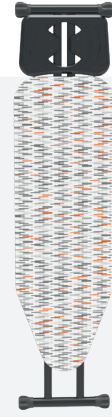

KOD
Code
15032

RENK
Color
●

36x112

monoblock

0,036 m² / pcs
40HC 1948



20x30

4 Pcs

96 Pcs

57 - 85 cm

Box Barcode
18691913015633



Product Name

Kapı Arkası

Teknik Özellikler

Technical Specifications

Minimum Order Quantity

Minimum Sipariş Adeti

MOQ1000



KOD
Code
15027

RENK
Color
●

32x110

perfore/mesh

0,024 m² / pcs
40HC 2904

20x20
Ø19

4 Pcs

160 Pcs



Product Name

**Present
Lux**

Teknik Özellikler

Technical Specifications

Minimum Order Quantity

Minimum Sipariş Adeti

MOQ1000



Ayarlanabilir
Ayak Takozu



Boru Kapama
Plastığı

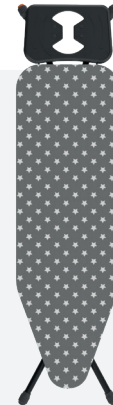
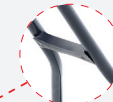

KOD
Code
15003

RENK
Color
●

38x120

perfore/mesh

0,033 m² / pcs
40HC 2092

Ø25

4 Pcs

112 Pcs

67 - 89 cm

Box Barcode
18691913011703





Product Name

IB-1008

Teknik Özellikler

Technical Specifications

Minimum Order Quantity

Minimum Sipariş Adeti

MOQ1000



KOD
Code
15031

RENK
Color

33x110

monoblock

0,020 m² / pcs
40HC 3672

Ø25 - Ø51

4 Pcs

96 Pcs

58 - 87 cm

Box Barcode
18691913015626

8 691913 4117712



Product Name

Alsu Lux

Teknik Özellikler

Technical Specifications

Minimum Order Quantity

Minimum Sipariş Adeti

MOQ1000



KOD
Code
15020

RENK
Color

30x105

perfore/mesh

0,020 m² / pcs
40HC 3672

Ø19

6 Pcs

180 Pcs

70 - 90 cm

Box Barcode
18691913003111

8 691913 701454

Minimum Order Quantity
Minimum Sipariş Adeti
MOQ 1000



Product Name
Fortune

Teknik Özellikler
Technical Specifications

Minimum Order Quantity
Minimum Sipariş Adeti
MOQ1000

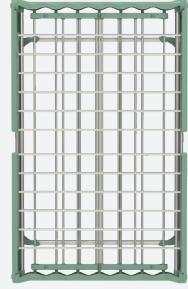

KOD
Code
17030

RENK
Color
Green

0,049 m² / pcs
40HC 1420

Ø08 - Ø16

4 Pcs

60 Pcs

25 M / 15 kg

Box Barcode
18691913015527

8 691913 117590

Product Name
Baronet

Teknik Özellikler
Technical Specifications

Minimum Order Quantity
Minimum Sipariş Adeti
MOQ1000



KOD
Code
17025

RENK
Color
Green

0,048 m² / pcs
40HC 1452

Ø8 - Ø16

6 Pcs

72 Pcs

16,5 M / 12 kg

Box Barcode
18691913004927

8 691913 110270

Product Name
Tiga

Teknik Özellikler
Technical Specifications

Minimum Order Quantity
Minimum Sipariş Adeti
MOQ1000



KOD
Code
17015

RENK
Color
Black

0,023 m² / pcs
40HC 3042

Ø19

2 Pcs

50 Pcs

20 M / 20 kg

8 691913 110256

Product Name

Laura

Teknik Özellikler

Technical Specifications

Minimum Order Quantity

Minimum Sipariş Adeti

MOQ1000



KOD

Code
17037

RENK

Color
Black

0,047 m² /pcs
40HC 1500

Ø16 - Ø8

4 Pcs

60 Pcs

15,5 M / 15 kg

Box Barcode
18691913012465

8 691913 118962

Product Name

Rima

Teknik Özellikler

Technical Specifications

Minimum Order Quantity

Minimum Sipariş Adeti

MOQ1000

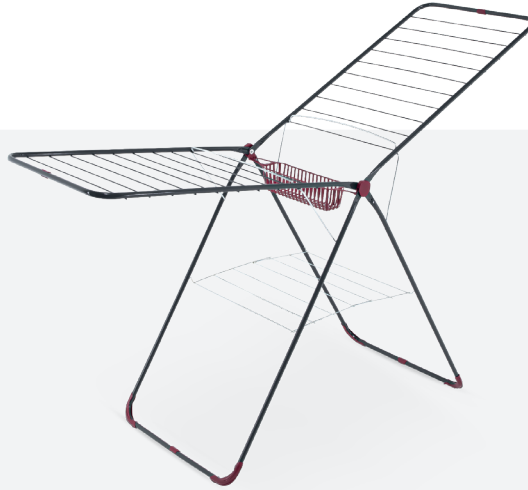

KOD

Code
17022

RENK

Color
Black

0,027 m² /pcs
40HC 1840

Ø16

4 Pcs

84 Pcs

20 M / 15 kg



Box Barcode
08691913150306

8 691913 440236



Petek Kurutmalık
Radiator Aier Laundry Dryer

Product Name

Sabina

Teknik Özellikler

Technical Specifications

Minimum Order Quantity

Minimum Sipariş Adeti

MOQ1000

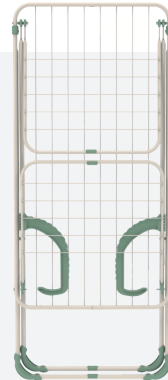
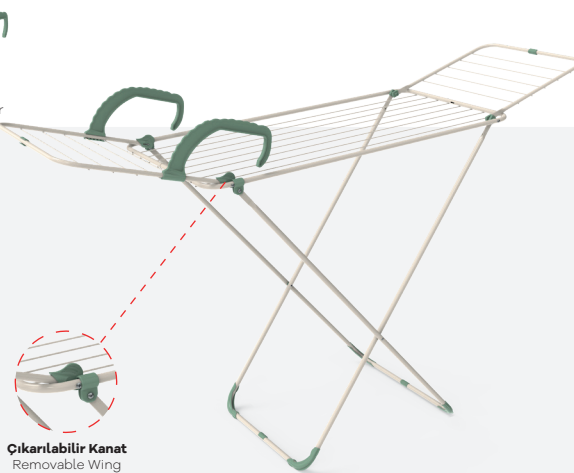

Çıkarılabilir Kanat
Removable Wing

KOD

Code
17021

RENK

Color
Beige

0,023 m² /pcs
40HC 3064

Ø16 - Ø14 - Ø12

8 Pcs

120 Pcs

17,5 M / 12 kg

Box Barcode
18691913003920

8 691913 117033

Product Name

Kapı Arkası

Teknik Özellikler

Technical Specifications

Minimum Order Quantity

Minimum Sipariş Adeti

MOQ 1000



KOD
Code

17018

RENK
Color



0,006 m² / pcs
40HC 8748

Ø16 - Ø8

12 Pcs

288 Pcs

6,5 M / 5 kg

Box Barcode
08691913150269

8 691913 701034

HousePlus

Product Name

LD-2003

Teknik Özellikler

Technical Specifications

Minimum Order Quantity

Minimum Sipariş Adeti

MOQ 3000

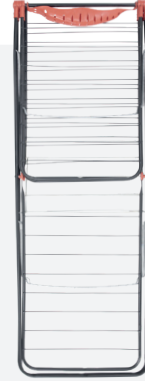
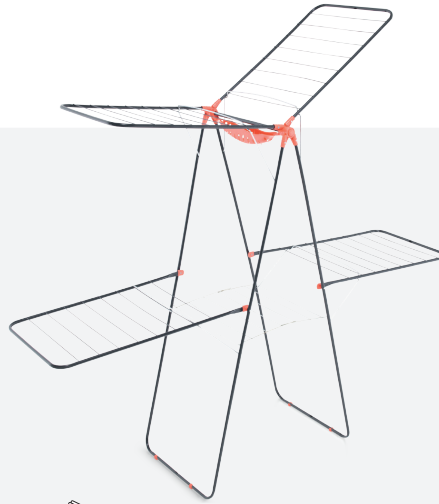

KOD
Code

17017

RENK
Color



0,045 m² / pcs
40HC 1520

Ø14

5 Pcs

105 Pcs

27 M / 18 kg



Box Barcode
08691913202012

8 691913 200216

HousePlus

Product Name

LD-2002

Teknik Özellikler

Technical Specifications

Minimum Order Quantity

Minimum Sipariş Adeti

MOQ 3000

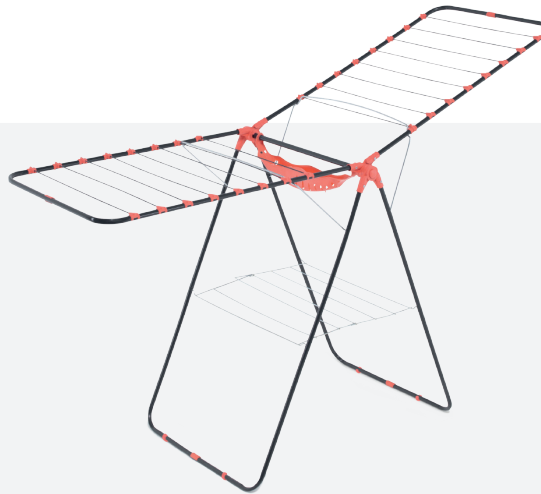

KOD
Code

17013

RENK
Color



0,029 m² / pcs
40HC 2408

Ø14

8 Pcs

96 Pcs

17 M / 10 kg



Box Barcode
08691913202005

8 691913 200208



**#seniniçin
#justforyou**

Paylaşılan
mutluluęu
çoęaltan
tasarımlar

Designs that
multiply shared
happiness.

#seniniçin
#justforyou

Konya Organize Sanayi
Bölgesi7.Sokak No:6 42250
KONYA/TÜRKİYE

T. +90 (332) 239 16 40
F. +90 (332) 239 16 49

Akçaburgaz Mah. Muhsin
Yazıcıoęlu Cad. NO:15
Kıraç - Esenyurt /
İstanbul / Turkey

T. +90 (212) 537 72 72
F. +90 (212) 537 33 42

info@perilla.com.tr | www.perilla.com.tr

444 42 10

